

SIRUBA®

銀爺牌工業用縫紉機

INDUSTRIAL SEWING MACHINE

700K

零件圖 PARÇA LİSTESİ







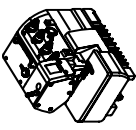

高林股份有限公司
KAULIN MFG. CO., LTD.

機型 MODEL	針板 NEEDLE PLATE	送具 FEED DOG	送具 FEED DOG	押具 PRESSER FOOT	勾針 LOOPER	針留 NEEDLE CLAMP	束子 COLLER	衝程 CRANK	衝程 CRANK	大心 Crankshaft	勾針連桿座 Upper Looper Holder	過線器 Bracket	下刀架 Lower Knife Holder	針號 NEEDLE
737K-504F1-04	E206	D201	D207	H201	P201-4A	LP225	KG231K-E	KJ204	KF203-E	KJ206-E	KD201	KJ236	KJ219	DC27#9
737K-504F1-15	E233	D233	D213	H233	P471J-A	LP225	KG231K-E	KJ204	KF203-E	KJ206-E	KD201	KJ236	KJ219	DC27#9
737K-504MI-15	E207	D201	D209	H201	P211-A	LP225	KG231K-E	KJ204	KF203-E	KJ206-E	KD201	KJ236	KJ219	DC27#9
737K-504MI-15VT	E207	D201	D209	H201	P211-A	LP225	KG231K-E	KJ204	KF203-E	KJ206-E	KD201	KJ236	KJ219	DC27#9
737K-504M2-04	E222	D210	D207	H204	P201-4A	LP225	KG231K-E	KJ204	KF203-E	KJ206-E	KD201	KJ236	KJ219	DC27#11
737K-504M2-04CT	E222	D210	D207	H204	P201-4A	LP225	KG231K-E	KJ204	KF203-E	KJ206-E	KD201	KJ236	KJ219	DC27#11
737K-504M2-04EC	E222	D210	D207	H204	P201-4A	LP225	KG231K-E	KJ204	KF203-E	KJ206-E	KD201	KJ236	KJ219	DC27#11
737K-504M2-04LFC-3	E222	D210	D207	H204	P216-3	LP225	KG231K-E	KJ204	KF203-E	KJ206-E	KD201	KJ236	KJ219	DC27#11
737K-504M2-04LFC-3/EC	E222	D210	D207	H204	P216-3	LP225	KG231K-E	KJ204	KF203-E	KJ206-E	KD201	KJ236	KJ219	DC27#11
737K-504M2-04TR	E222	D210	D207	H204	P216-3	LP225	KG231K-E	KJ204	KF203-E	KJ206-E	KD201	KJ236	KJ219	DC27#11
737K-504M2-04TR/EC	E222	D210	D207	H204	P216-3	LP225	KG231K-E	KJ204	KF203-E	KJ206-E	KD201	KJ236	KJ219	DC27#11
737K-504M2-04VT	E222	D210	D207	H204	P201-4A	LP225	KG231K-E	KJ204	KF203-E	KJ206-E	KD201	KJ236	KJ219	DC27#11
737K-WR/LFC-3	E246					LP225	KG231K-E	KJ204	KF203-E	KJ206-E	KD201	KJ236	KJ219	DC27#11
737K-504M3-04	E220	D210	D209	H204	P201-4A	LP225	KG231K-E	KJ204	KF203-E	KJ206-E	KD201	KJ236	KJ219	DC27#11
737K-504M3-05	E221	D210	D209	H204	P201-4A	LP225	KG231K-E	KJ204	KF203-E	KJ206-E	KD201	KJ236	KJ219	DC27#11
737K-504M3-05CT	E221	D210	D209	H204	P201-4A	LP225	KG231K-E	KJ204	KF203-E	KJ206-E	KD201	KJ236	KJ219	DC27#11
737K-504M3-05PZ	E221	D210	D209	H204	P257-A	LP225	KG231K-E	KJ204	KF203-E	KJ206-E	KD201	KJ236	KJ219	DC27#18
737K-504M3-05VT	E221	D210	D209	H204	P201-4A	LP225	KG231K-E	KJ204	KF203-E	KJ206-E	KD201	KJ236	KJ219	DC27#11
737K-504M5-04BK	E232	D203	D207	H203	P202-2A	LP225	KG231K-E	KJ204	KF203-E	KJ206-E	KD201	KJ236	KJ219	DC27#11
737K-504M5-04BK/VT	E232	D203	D207	H203	P202-2A	LP225	KG231K-E	KJ204	KF203-E	KJ206-E	KD201	KJ236	KJ219	DC27#11
737K-505F1-04	E206	D201	D207	H201	P203-A	LP225	KG231K-E	KJ204	KF203-E	KJ206-E	KD201	KJ236	KJ219	DC27#9
737K-505F1-04VT	E206	D201	D207	H201	P203-A	LP225	KG231K-E	KJ204	KF203-E	KJ206-E	KD201	KJ236	KJ219	DC27#9
747K-512M1-25	E208	D210	D207	H204	P201-5A	LP228	KG242K-E	KJ204	KF215-E	KJ203-E	KD201	KJ208	KJ219	DC27#11*2
747K-512M1-25CT	E208	D210	D207	H204	P201-5A	LP228	KG242K-E	KJ204	KF215-E	KJ203-E	KD201	KJ208	KJ219	DC27#11*2
747K-512M1-34	E236	D210	D207	H204	P214-A	LP228	KG254K-E	KJ204	KF215-E	KJ203-E	KD201	KJ208	KJ219	DC27#14*2
747K-514F1-24	E212	D210	D207	H204	P201-3A	LP229	KG242K-E	KJ234+KL15	KF203-E	KJ203-E	KD201	KJ208	KJ219	DC27#11*2
747K-514H4-24GA	E229	D202	D207	H202	P204-A	LP226	KG242K-E	KJ234+KL15	KF203-E	KJ203-E	KD201	KJ208	KJ219	DC27#11*2
747K-514H4-24GA/CT	E229	D202	D207	H202	P204-A	LP226	KG242K-E	KJ234+KL15	KF203-E	KJ203-E	KD201	KJ208	KJ219	DC27#11*2
747K-514H4-24GA/EC	E229	D202	D207	H202	P204-A	LP226	KG242K-E	KJ234+KL15	KF203-E	KJ203-E	KD201	KJ208	KJ219	DC27#11*2
747K-514H4-24GA/P	E229	D202	D207	H202	P204P-A	LP226	KG242K-E	KJ234+KL15	KF203-E	KJ203-E	KD201	KJ208	KJ219	DC27#11*2
747K-514M2-24	E229	D210	D207	H204	P201-A	LP226	KG242K-E	KJ234+KL15	KF203-E	KJ203-E	KD201	KJ208	KJ219	DC27#11*2
747K-514M2-24CT	E229	D210	D207	H204	P201-A	LP226	KG242K-E	KJ234+KL15	KF203-E	KJ203-E	KD201	KJ208	KJ219	DC27#11*2
747K-514M2-24EC	E229	D210	D207	H204	P201-A	LP226	KG242K-E	KJ234+KL15	KF203-E	KJ203-E	KD201	KJ208	KJ219	DC27#11*2

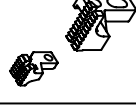
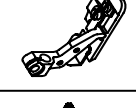
規格件表 DONUSTURME SEMASI

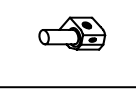
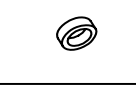
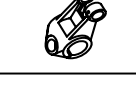
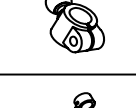
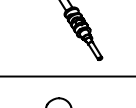
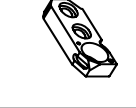
規格件表 DONUSTURME SEMASI

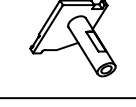
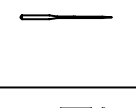
													
機 型 MODEL	針板 NEEDLE PLATE	送具 FEED DOG	押具 PRESSER FOOT	勾 針 LOOPER	針留 NEEDLE CLAMP	束 子 COLLER	衝 程 CRANK	衝 程 CRANK	大 心 Crankshaft	勾針連焊座 Upper Looper Holder	過線器 Bracket	下刀架 Lower Knife Holder	針 號 NEEDLE
747K-514M2-24LFC-3	E229	D210	P216-4	LP226	KG242K-E	KJ234+KJL15	KF203-E	KJ203-E	KD201	KJ208	KJ219	KR209	DC27#11*2
747K-514M2-24LFC-3/EC		D207	P216-4										
747K-514M2-24TG			P254J-4A			KJ234+KJL15	KF203-E	KJ203-E	KD201	KJ20			
747K-514M2-24TG/EC			-J-4A		KG242K-E	KJ234+KJL15	KF203-E	KJ203-E	KD201	KJ208	KJ219	KR209	DC27#11*2
747K-514M2-24VT	E229	D210	P201-A	LP226	KG242K-E	KJ234+KJL15	KF203-E	KJ203-E	KD201	KJ208	KJ219	KR209	DC27#11*2
747K-514M2-25	E208	D210	P201-A	LP226	KG242K-E	KJ234+KJL15	KF203-E	KJ203-E	KD201	KJ208	KJ219	KR209	DC27#11*2
747K-514M2-25CT	E208	D210	P201-A	LP226	KG242K-E	KJ234+KJL15	KF203-E	KJ203-E	KD201	KJ208	KJ219	KR209	DC27#11*2
747K-514M2-25CT	E208	D210	P254J-4A	LP226	KG242K-E	KJ234+KJL15	KF203-E	KJ203-E	KD201	KJ208	KJ219	KR209	DC27#11*2
747K-514M2-25TG	E230	D210	P201-8A	LP227A	KG242K-E	KJ204+KJ234*2	KF203-E	KJ203-E	KD201A	KJ228	KJ238	KR209	DC27#11*2
747K-514M2-28	E209	D210	P201-2A	LP226	KG242K-E	KJ234+KJL15	KF203-E	KJ203-E	KD201	KJ208	KJ219	KR209	DC27#11*2
747K-514M4-23	E209	D210	P201-2A	LP226	KG242K-E	KJ234+KJL15	KF203-E	KJ203-E	KD201	KJ208	KJ219	KR209	DC27#11*2
747K-514M4-23/CT	E210	D203	P202-A	LP226	KG242K-E	KJ234+KJL15	KF203-E	KJ203-E	KD201	KJ208	KJ219	KR209	DC27#11*2
747K-514M5-23BK	E210	D203	P202-A	LP226	KG242K-E	KJ234+KJL15	KF203-E	KJ203-E	KD201	KJ208	KJ219	KR209	DC27#11*2
747K-514M5-23BK/VT	E210	D203	P202-A	LP226	KG242K-E	KJ234+KJL15	KF203-E	KJ203-E	KD201	KJ208	KJ219	KR209	DC27#11*2
747K-514M7-24	E226	D212	P201-A	LP230	KG242K-E	KJ204+KJ234*2	KF203-E	KJ203-E	KD201A	KJ228	KJ238	KR209	DC27#16*2
747K-514M7-24BK	E247	D203	P202-A	LP230	KG242K-E	KJ204+KJ234*2	KF203-E	KJ203-E	KD201A	KJ228	KJ238	KR209	DC27#16*2
747K-514M7-24CT	E226	D212	P201-A	LP230	KG242K-E	KJ204+KJ234*2	KF203-E	KJ203-E	KD201A	KJ228	KJ238	KR209	DC27#16*2
747K-514M7-24TG	E226	D212	P254J-4A	LP230	KG242K-E	KJ204+KJ234*2	KF203-E	KJ203-E	KD201A	KJ228	KJ238	KR209	DC27#16*2
747K-514M7-25	E225	D212	P201-5A	LP230	KG242K-E	KJ204+KJ234*2	KF203-E	KJ203-E	KD201A	KJ228	KJ238	KR209	DC27#16*2
747K-514M7-25BK	E248	D203	P202-A	LP230	KG242K-E	KJ204+KJ234*2	KF203-E	KJ203-E	KD201A	KJ228	KJ238	KR209	DC27#16*2
747K-514M7-25CT	E225	D212	P201-5A	LP230	KG242K-E	KJ204+KJ234*2	KF203-E	KJ203-E	KD201A	KJ228	KJ238	KR209	DC27#16*2
747K-514M7-25TG	E225	D212	P254J-4A	LP230	KG242K-E	KJ204+KJ234*2	KF203-E	KJ203-E	KD201A	KJ228	KJ238	KR209	DC27#16*2
757K-401M1/TW	E237	D219	P506-A		KG253K-E	KJ204	KF203-E	KJ206-E	KD201	TW201			DC27#14*1
757K-516H4-35GA	E213	D204	P508J-A	LP226	KG253K-E	KJ204	KF203-E	KJ206-E	KD201	KJ236	KJ219	KR219	DC27#14*2
757K-516H4-35GA/EC	E213	D204	P508J-A	LP226	KG253K-E	KJ204	KF203-E	KJ206-E	KD201	KJ236	KJ219	KR219	DC27#14*2
757K-516H4-35GA/P	E213	D204	P508JP-A	LP226	KG253K-E	KJ204	KF203-E	KJ206-E	KD201	KJ236	KJ219	KR219	DC27#14*2
757K-516H4-35GA/P/EC	E213	D204	P508JP-A	LP226	KG253K-E	KJ204	KF203-E	KJ206-E	KD201	KJ236	KJ219	KR219	DC27#14*2
757K-516H4-55GA	E214	D205	P509J-A	LP226	KG255K-E	KJ204	KF203-E	KJ206-E	KD201	KJ236	KJ219	KR219	DC27#14*2
757K-516H4-55GA/EC	E214	D205	P509J-A	LP226	KG255K-E	KJ204	KF203-E	KJ206-E	KD201	KJ236	KJ219	KR219	DC27#14*2
757K-516H4-55GA/P	E214	D205	P509JP-A	LP226	KG255K-E	KJ204	KF203-E	KJ206-E	KD201	KJ236	KJ219	KR219	DC27#14*2
757K-516H4-55GA/P/EC	E214	D205	P509JP-A	LP226	KG255K-E	KJ204	KF203-E	KJ206-E	KD201	KJ236	KJ219	KR219	DC27#14*2
757K-516L1-24	E215	D206	P500J-A	LP225	KG252K-E	KJ204	KF203-E	KJ206-E	KD201	KJ236	KJ219	KR219	DC27#14*2
757K-516L1-24CT	E215	D206	P500J-A	LP225	KG252K-E	KJ204	KF203-E	KJ206-E	KD201	KJ236	KJ219	KR219	DC27#14*2
757K-516L1-35	E216	D206	P504J-A	LP225	KG253K-E	KJ204	KF203-E	KJ206-E	KD201	KJ236	KJ219	KR219	DC27#14*2

機 型 MODEL	針板 NEEDLE PLATE	送具 FEED DOG	送具 FEED DOG	送具 FEED DOG	押具 PRESSER FOOT	勾 針 LOOPER	針留 NEEDLE CLAMP	束 子 COLLER	衝 程 CRANK	衝 程 CRANK	大 心 Crankshaft	勾針連桿座 Upper Looper	過線器 Bracket	下刀架 Lower Knife Holder	針 號 NEEDLE
757K-516L1-35CT	E216	D206	D207	H212	P504J-A	LP225	KG253K-E	KJ204	KF203-E	KJ206-E	KD201	KJ236	KJ219	KR219	DC27#14*2
757K-516M2-35	E217	D208	D207	H208	P504J-A	LP226	KG253K-E	KJ204	KF203-E	KJ206-E	KD201	KJ236	KJ219	KR219	DC27#14*2
757K-516M2-35CT	E217	D208	D207	H208	P504J-A	LP226	KG253K-E	KJ204	KF203-E	KJ206-E	KD201	KJ236	KJ219	KR219	DC27#14*2
757K-516M2-35PS	E227	D208	D207	H214	P504JS-A	LP226	KG253K-E	KJ204	KF203-E	KJ206-E	KD201	KJ236	KJ219	KR219	DC27#14*2
757K-516M2-35PS/EC	E227	D208	D207	H214	P504JS-A	LP226	KG253K-E	KJ204	KF203-E	KJ206-E	KD201	KJ236	KJ219	KR219	DC27#14*2
757K-516M2-55	E218	D208	D207	H209	P502J-A	LP226	KG255K-E	KJ204	KF203-E	KJ206-E	KD201	KJ236	KJ219	KR219	DC27#14*2
757K-516M2-55CT	E218	D208	D207	H209	P502J-A	LP226	KG255K-E	KJ204	KF203-E	KJ206-E	KD201	KJ236	KJ219	KR219	DC27#14*2
757K-516M2-55EC	E218	D208	D207	H209	P502J-A	LP226	KG255K-E	KJ204	KF203-E	KJ206-E	KD201	KJ236	KJ219	KR219	DC27#14*2
757K-516M2-55PS	E228	D208	D207	H215	P502JS-A	LP226	KG255K-E	KJ204	KF203-E	KJ206-E	KD201	KJ236	KJ219	KR219	DC27#14*2
757K-516M2-55PS/EC	E228	D208	D207	H215	P502JS-A	LP226	KG255K-E	KJ204	KF203-E	KJ206-E	KD201	KJ236	KJ219	KR219	DC27#14*2
757K-401M2-50TA	E238	D211	D222	H216	P223-A	LP226	KG255K-E	KJ204	KF203-E	KJ206-E	KD201	TW201	KJ219	KR219	DC27#14*2
767K-516M2-324	E219	D208	D207	H209	P233J-A	LP226	KG433K-E	KJ234+KJL15	KF203-E	KJ203-E	KD201	KJ208	KJ219	KR219	DC27#11*3
767K-516M2-324/CT	E219	D208	D207	H209	P233J-A	LP226	KG433K-E	KJ234+KJL15	KF203-E	KJ203-E	KD201	KJ208	KJ219	KR219	DC27#11*3
767K-516M2-524	E224	D208	D207	H209	P255J-A	LP226	KG455K-E	KJ234+KJL15	KF203-E	KJ203-E	KD201	KJ208	KJ219	KR219	DC27#11*3
767K-516M2-524/CT	E224	D208	D207	H209	P255J-A	LP226	KG455K-E	KJ234+KJL15	KF203-E	KJ203-E	KD201	KJ208	KJ219	KR219	DC27#11*3

KA GRUP İÇİN PARÇA LİSTESİ

KB GRUP İÇİN PARÇA LİSTESİ

MODEL	700K/KD	986/988D
PARTS NO	KC230	KC231

MODEL	3線/4線	5線/6線
PARTS NO	KA224	

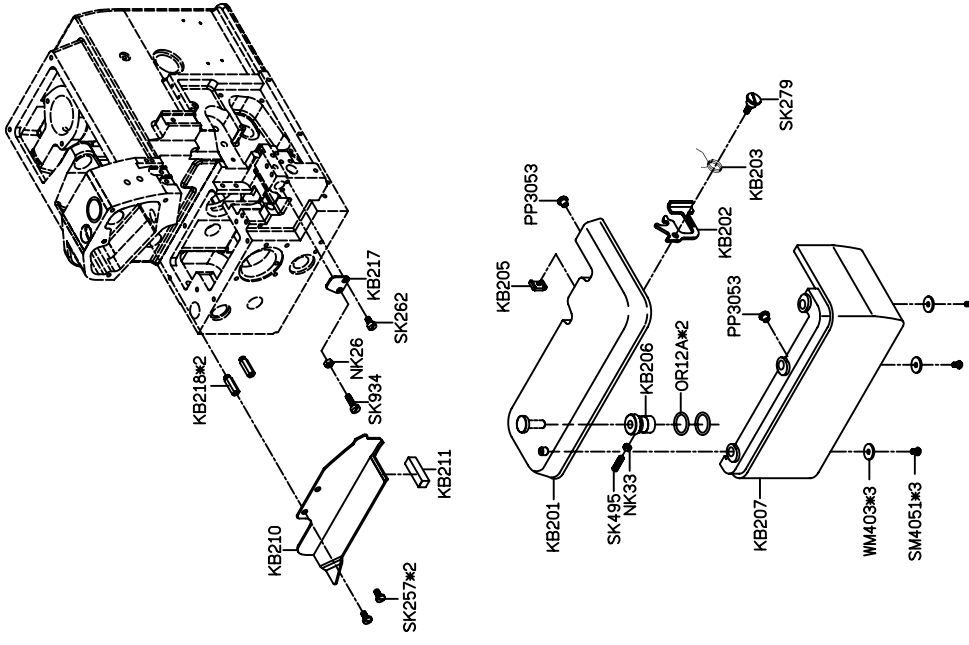
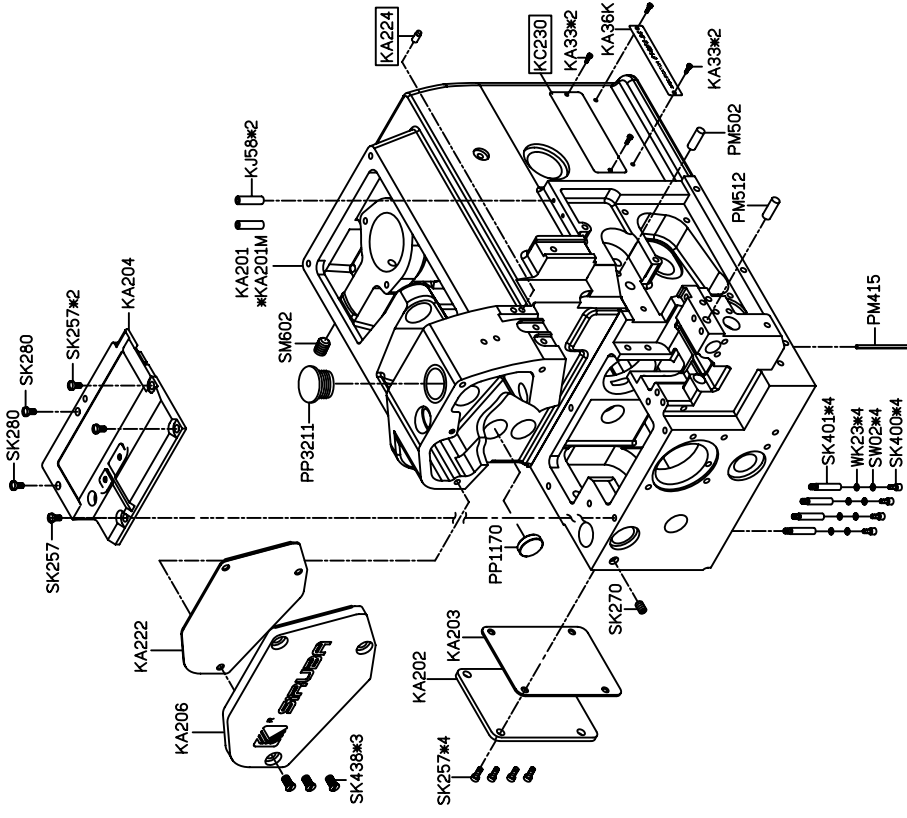

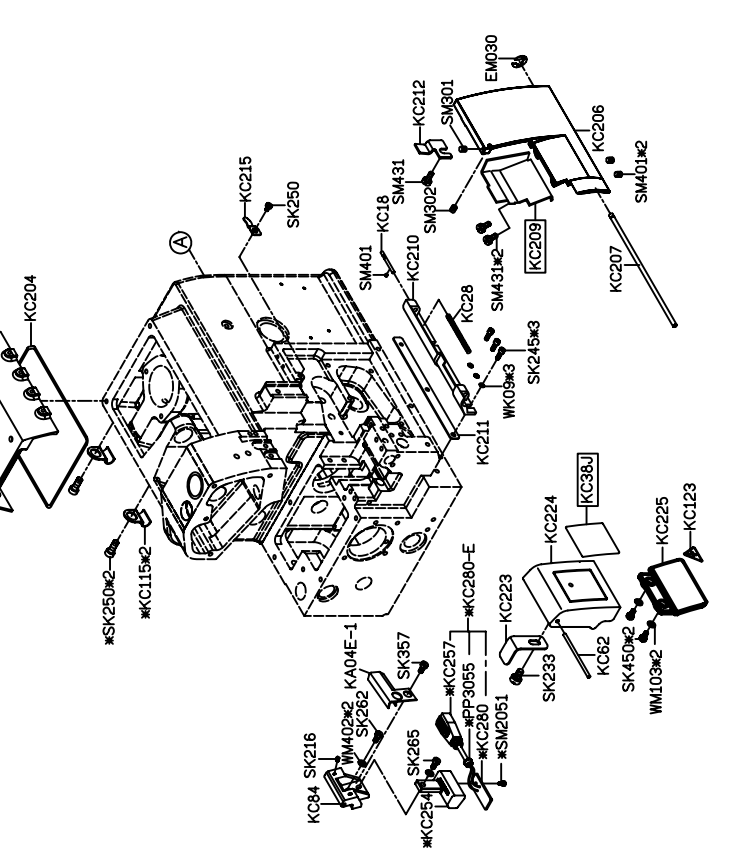
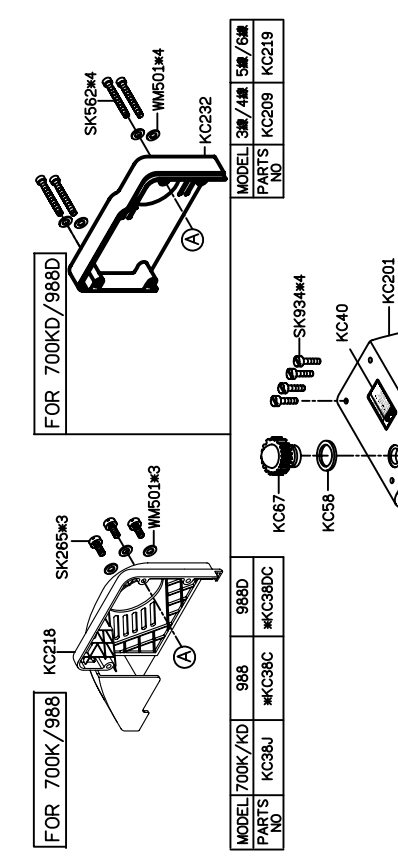
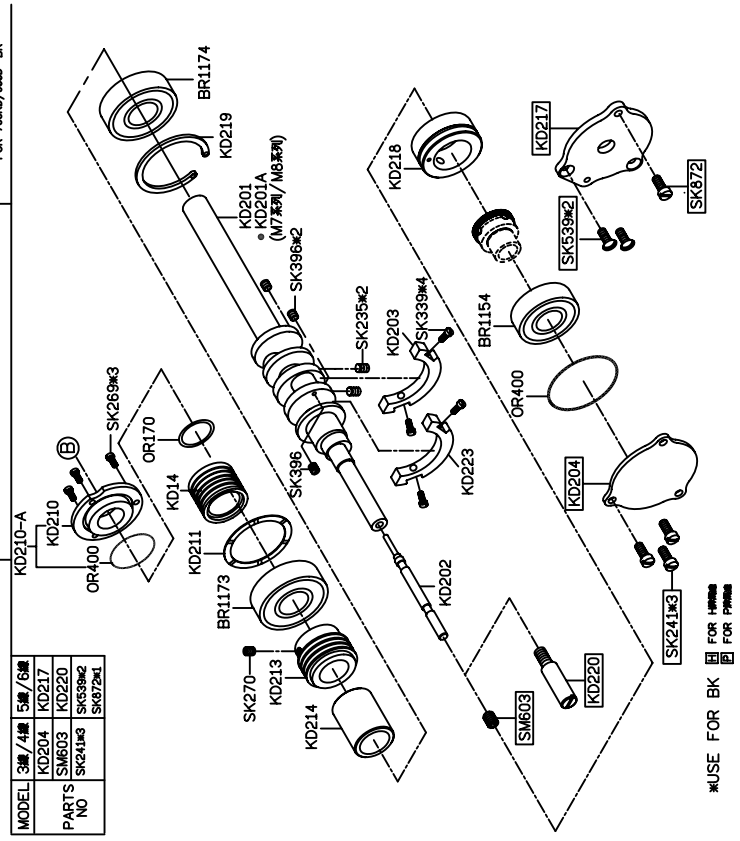
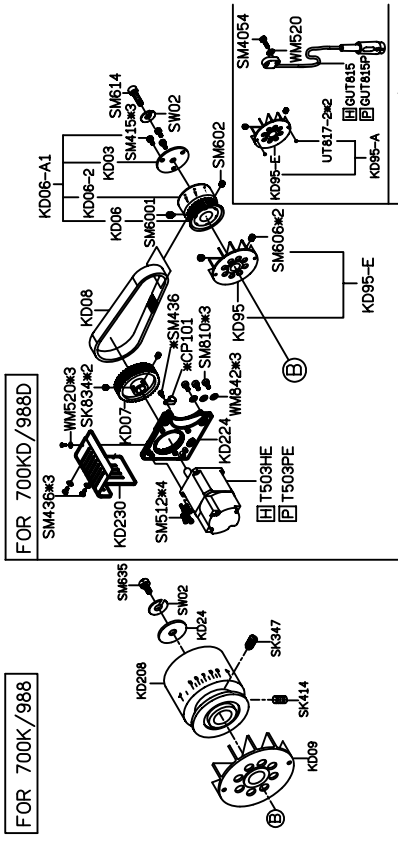

KC GRUP İÇİN PARÇA LİSTESİ

KD GRUP İÇİN PARÇA LİSTESİ

KF GRUP İÇİN PARÇA LİSTESİ

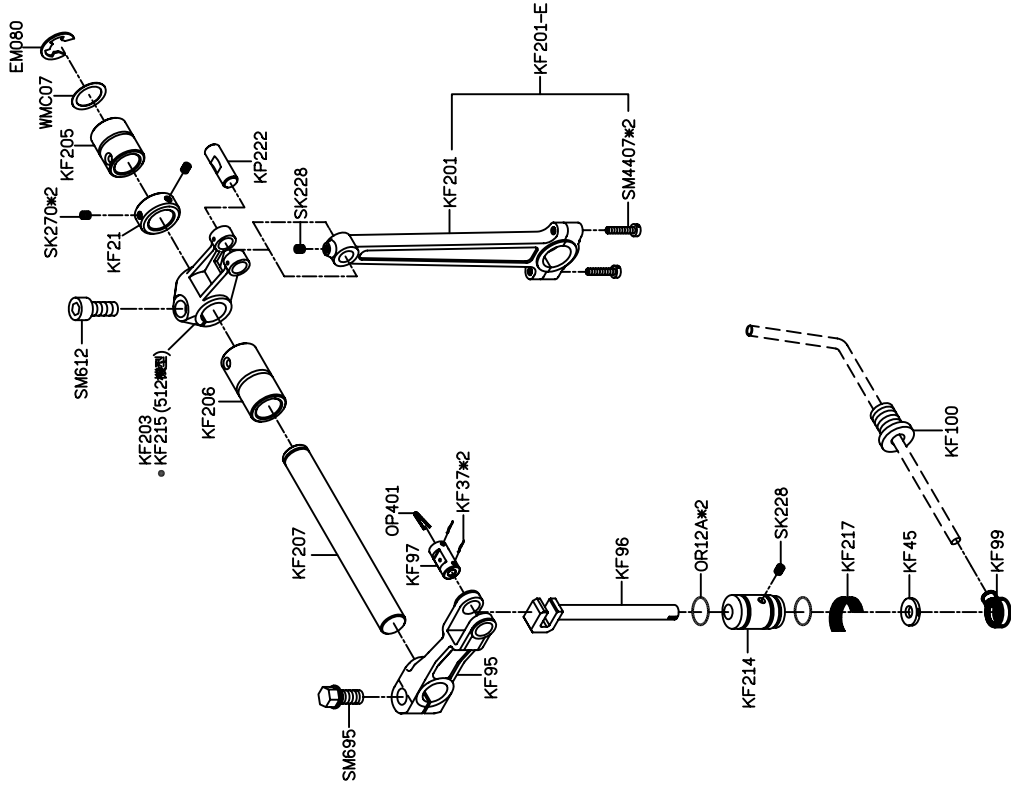

KG GRUP İÇİN PARÇA LİSTESİ

MODEL	3#	4#	5#	6#
	KG233	KG211	KG233	KG211
	KG248	KG213	KG236	KG249
	KG250	KG221	KG243	KG251
	KG222	KG225	KG245	KG245
	KG201	KG201	KG261	KG261
	KG693	KG592	KG244	KG244
	SK250N	SK216	SK216	SK216
	SK250N	SK250N	SK250N	SK250N
	SK1437N	SK1437N	SK1437	SK1437
	SK221N	SK221N	SK221N	SK221N
	SK251	SK251	SK250	SK250

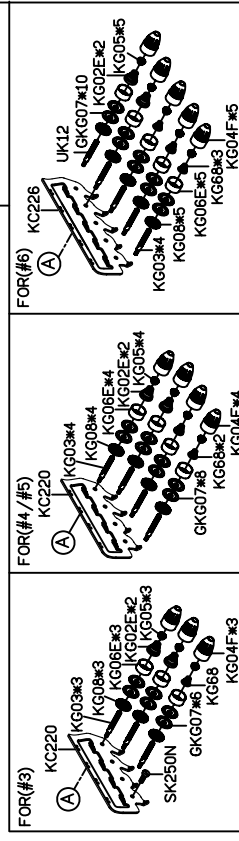
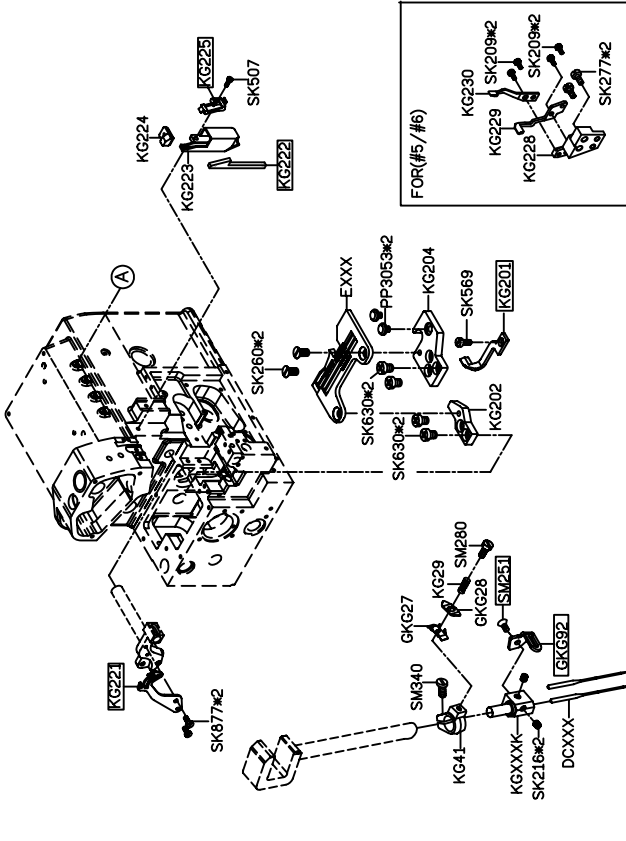
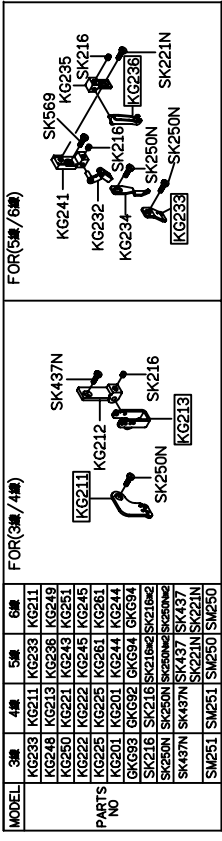

MODEL	3機/4機
PARTS NO	KL205

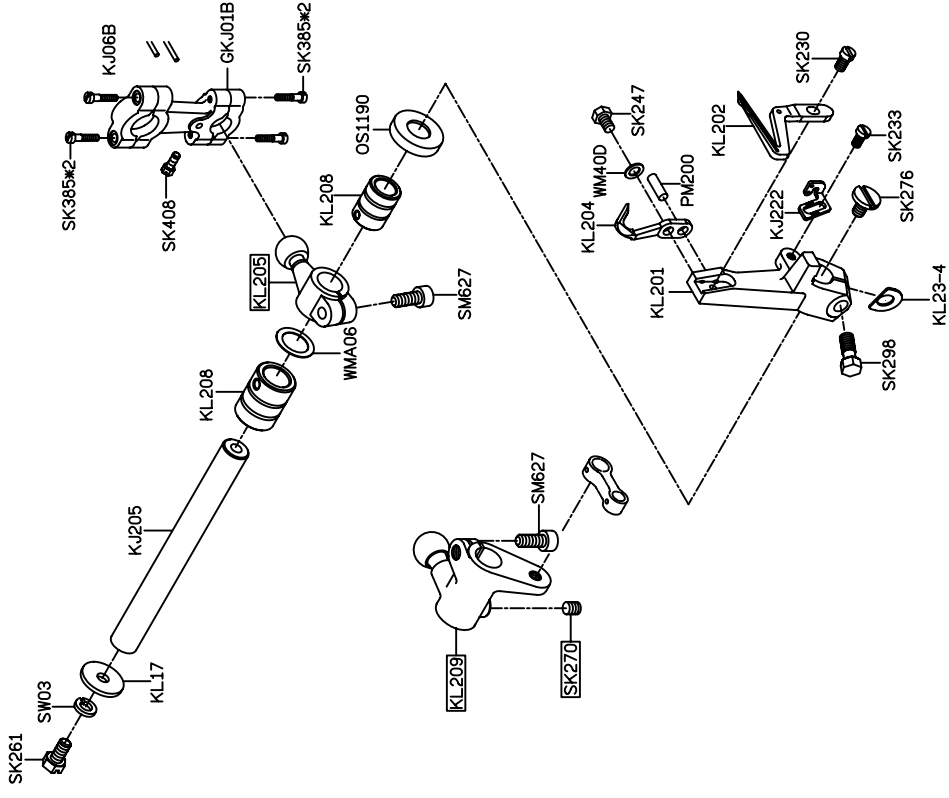

MODEL	3機/5機	4機/6機	4機M7/M8系列
PARTS NO	KJ204	KJ234+KL15	KJ204+KJ23*2
	KJ206	KJ203	KJ203
	KJ236	KJ208	KJ228
	KJ219		KJ238

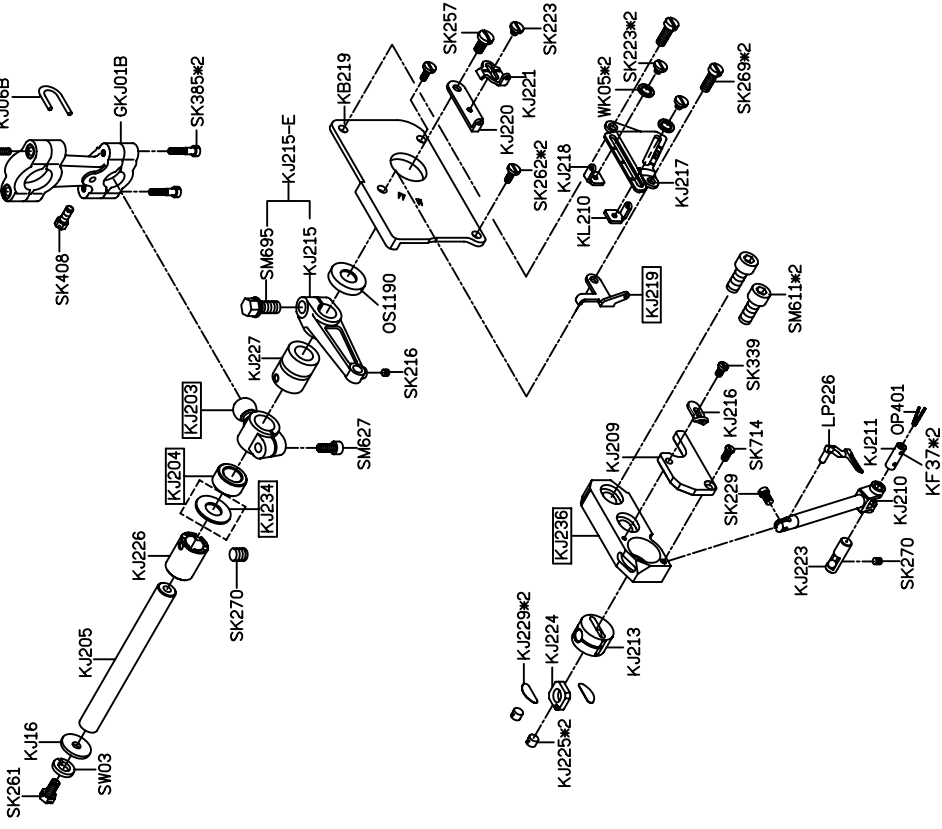

KJ GRUP İÇİN PARÇA LİSTESİ

KL GRUP İÇİN PARÇA LİSTESİ

KM GRUP İÇİN PARÇA LİSTESİ

KN GRUP İÇİN PARÇA LİSTESİ

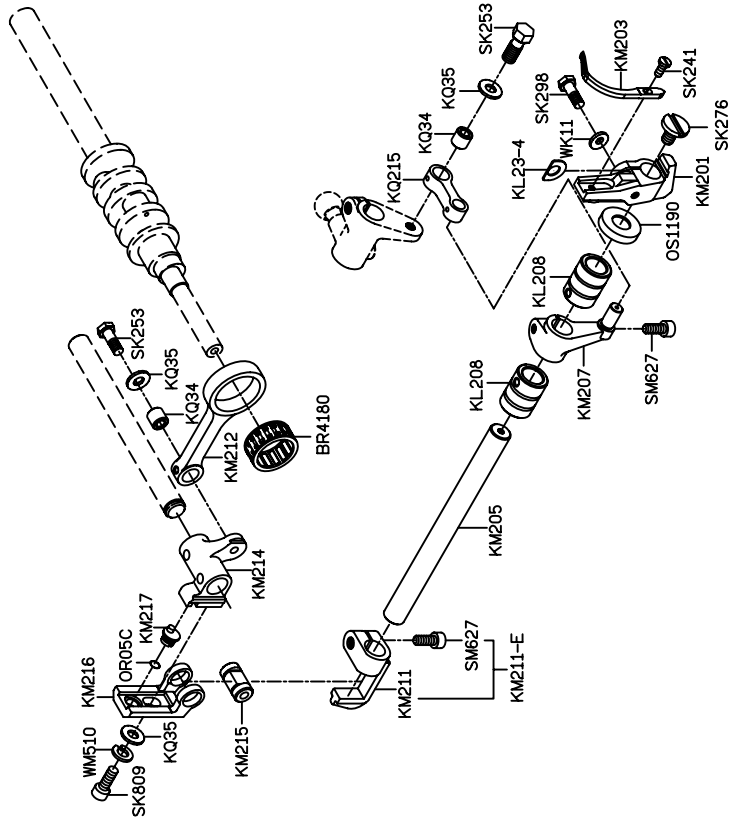
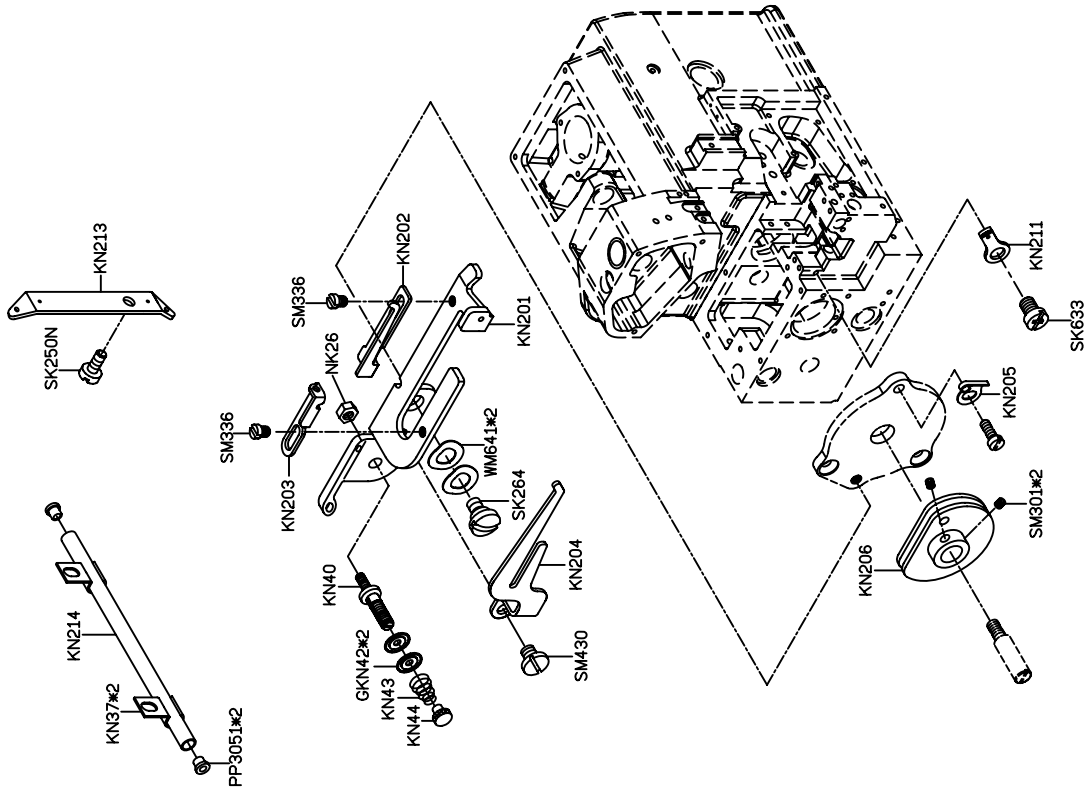

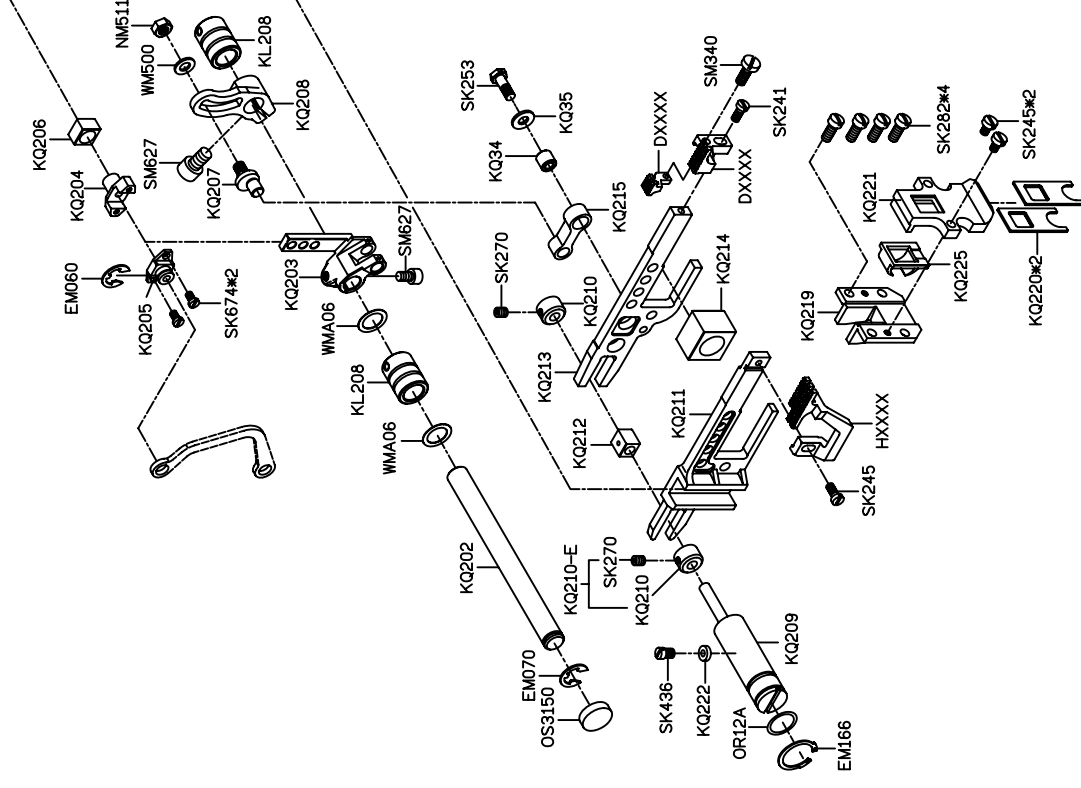
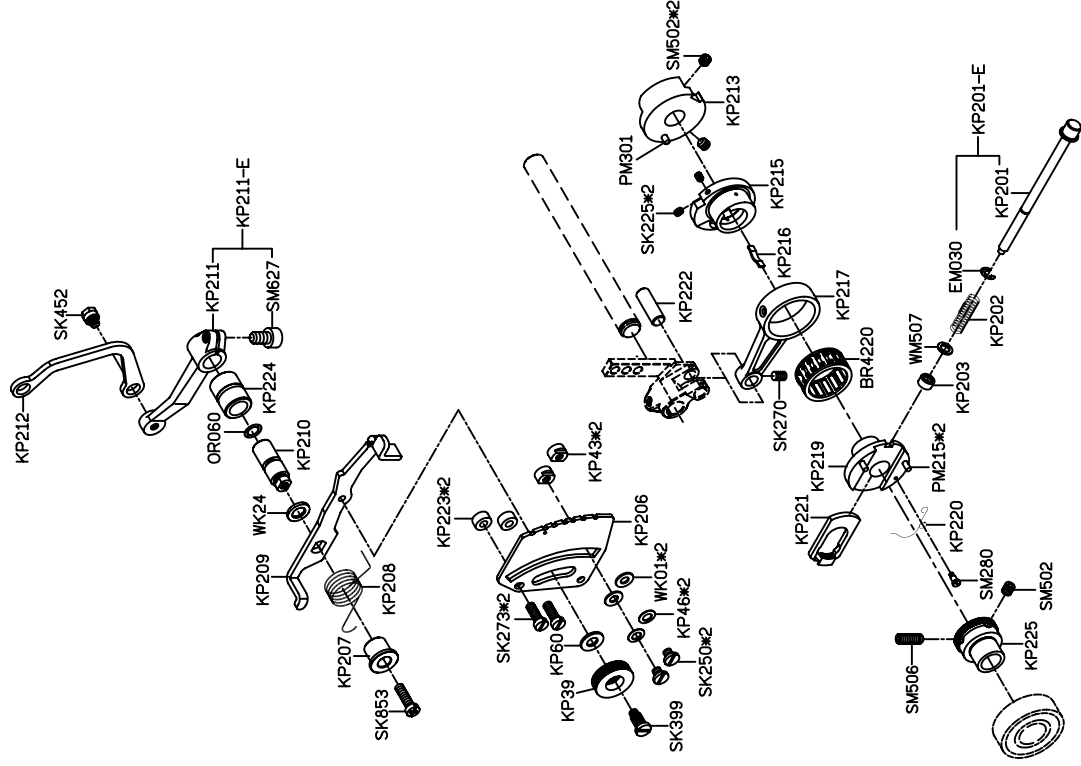

KP GRUP İÇİN PARÇA LİSTESİ

KQ GRUP İÇİN PARÇA LİSTESİ

MODEL	3線/4線	5線/6線
PARTS NO	GKU40	GKU39
	KU207	KU209
	KU206	KU211
	SK277	SK437

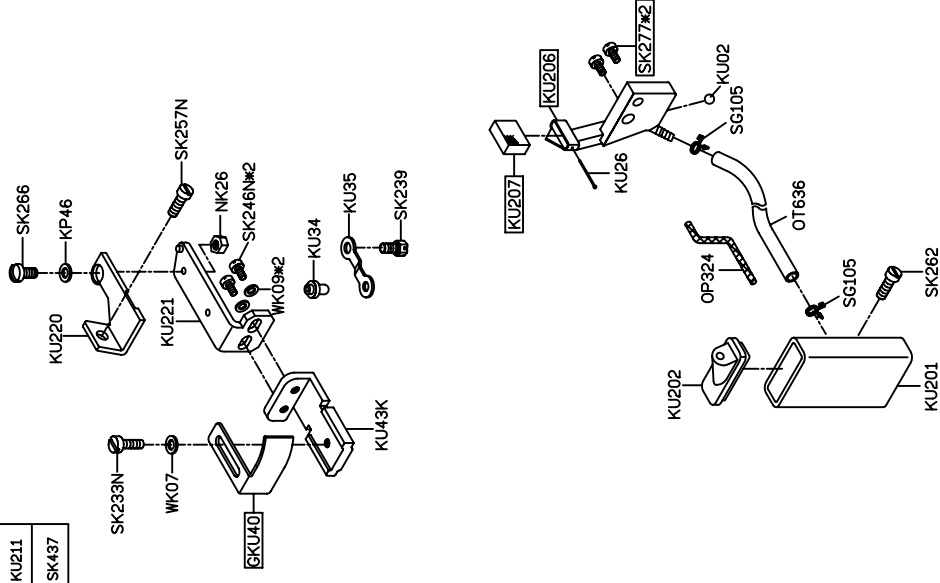
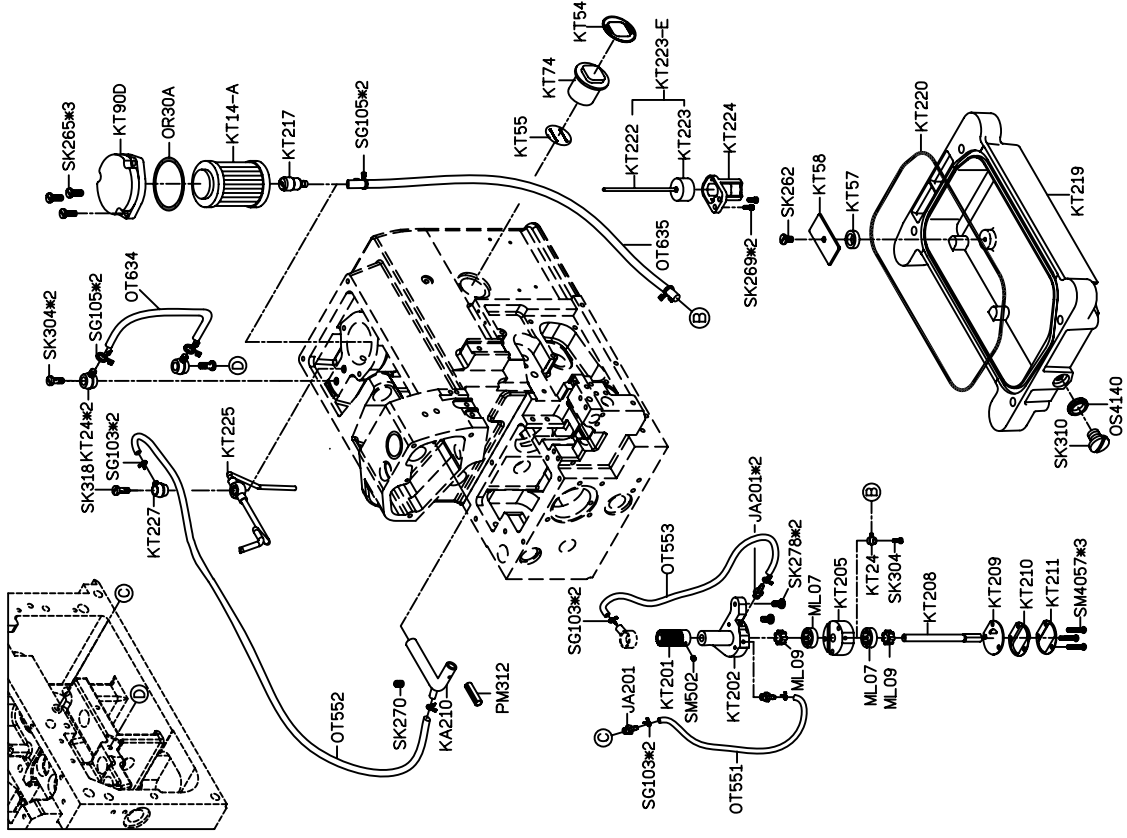

KT GRUP İÇİN PARÇA LİSTESİ

KU GRUP İÇİN PARÇA LİSTESİ

THREAD STAND GRUP İÇİN PARÇA LİSTESİ

THREAD STAND GRUP İÇİN PARÇA LİSTESİ

KW40E-3

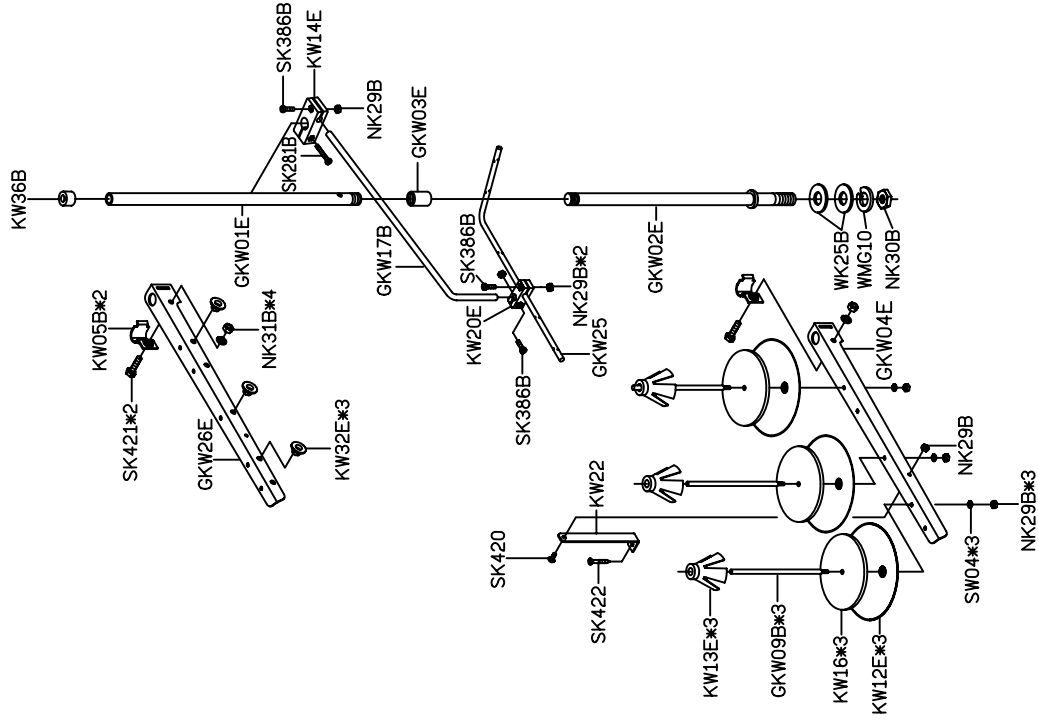

KW40E-4

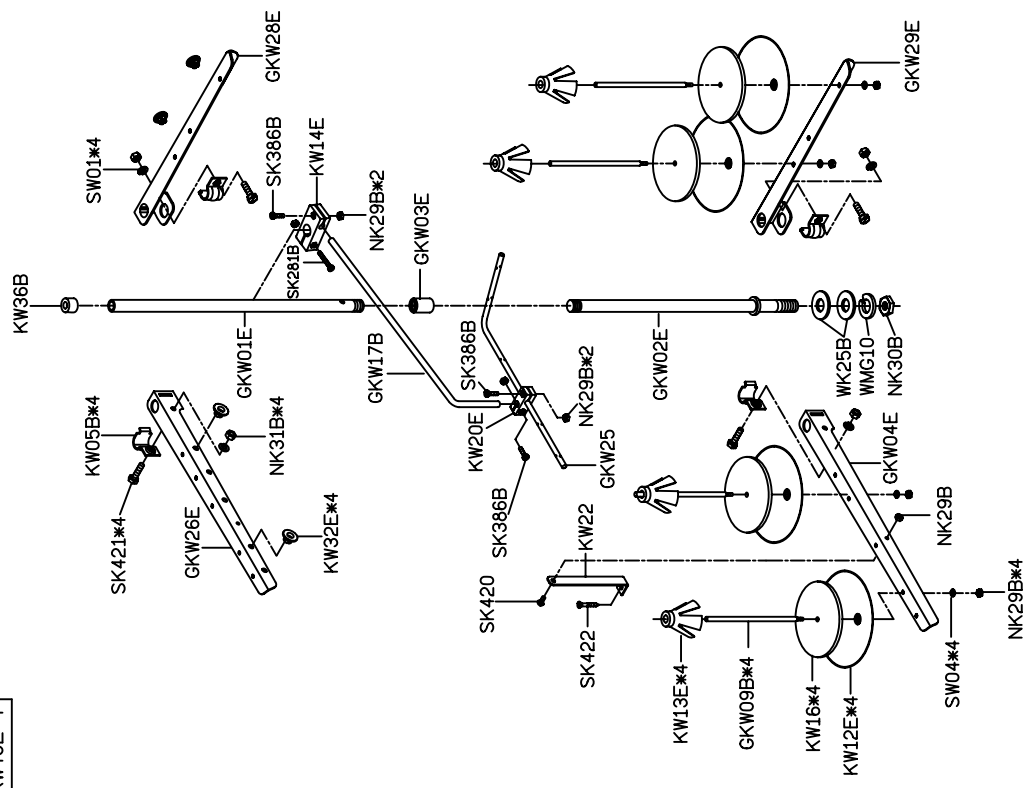

KW40E-5

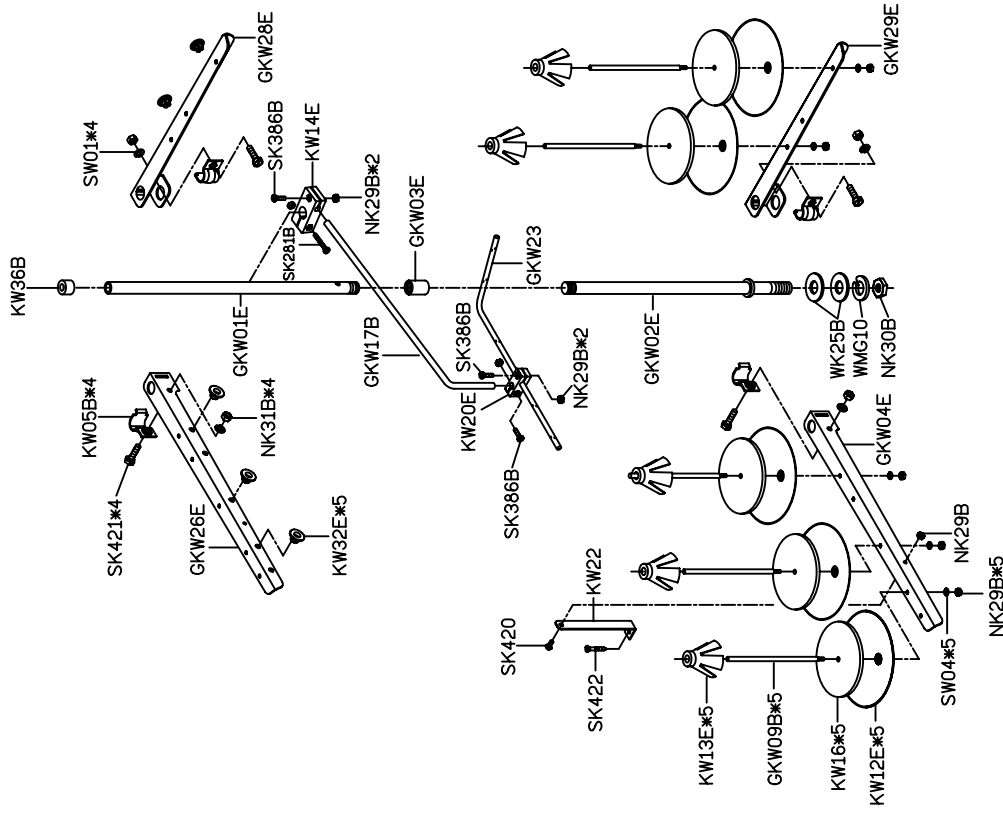

KW40E-6

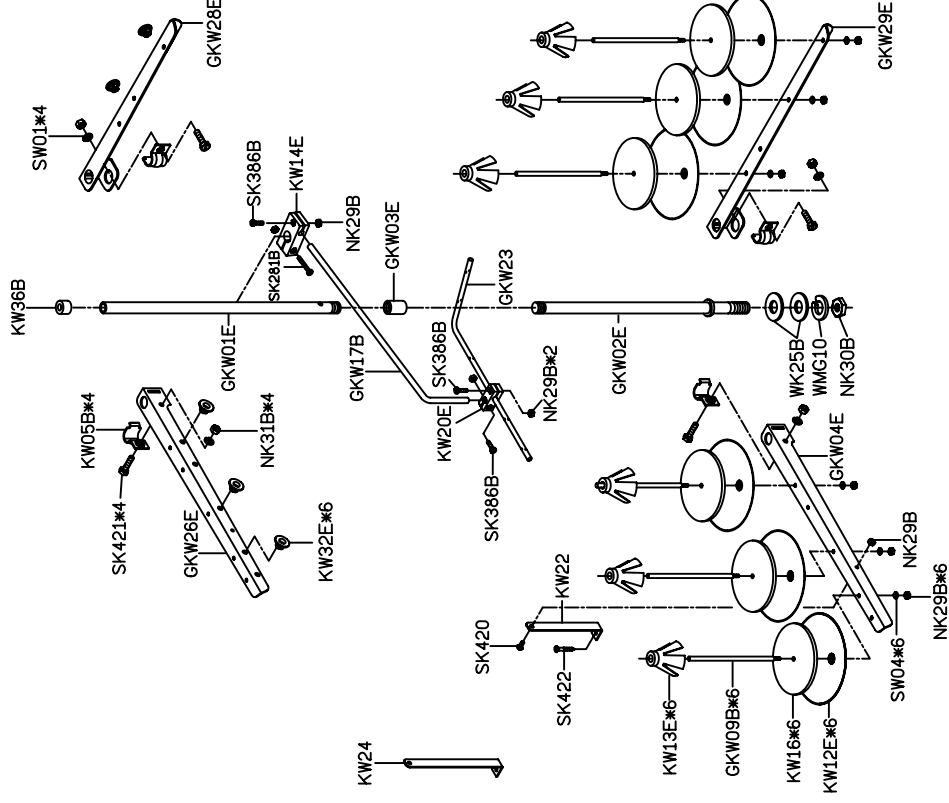

KX GRUP İÇİN PARÇA LİSTESİ

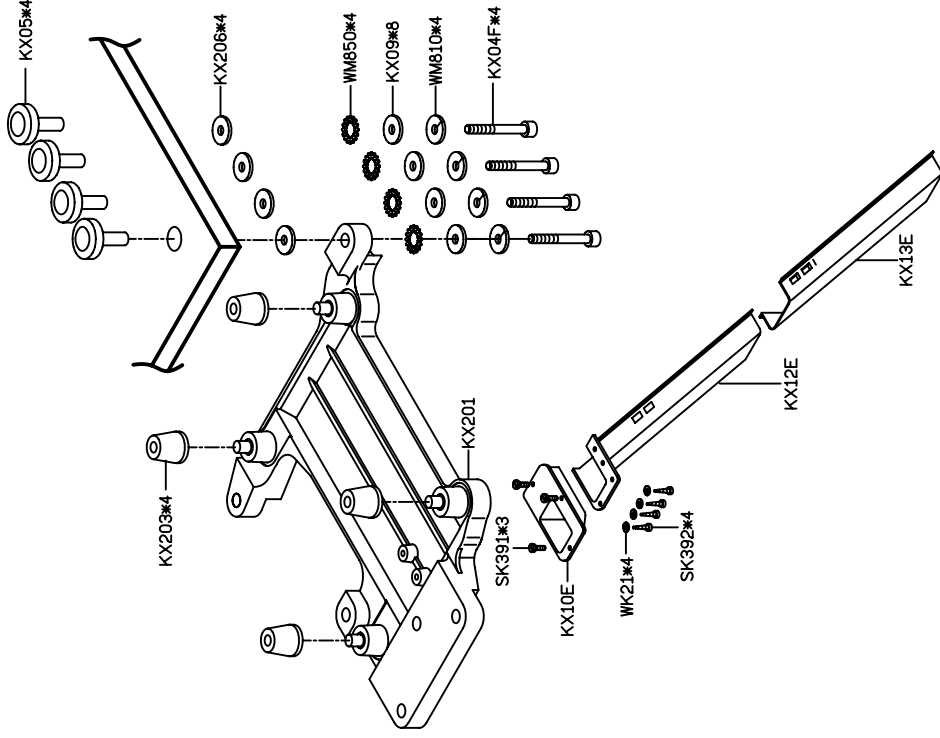

KY GRUP İÇİN PARÇA LİSTESİ

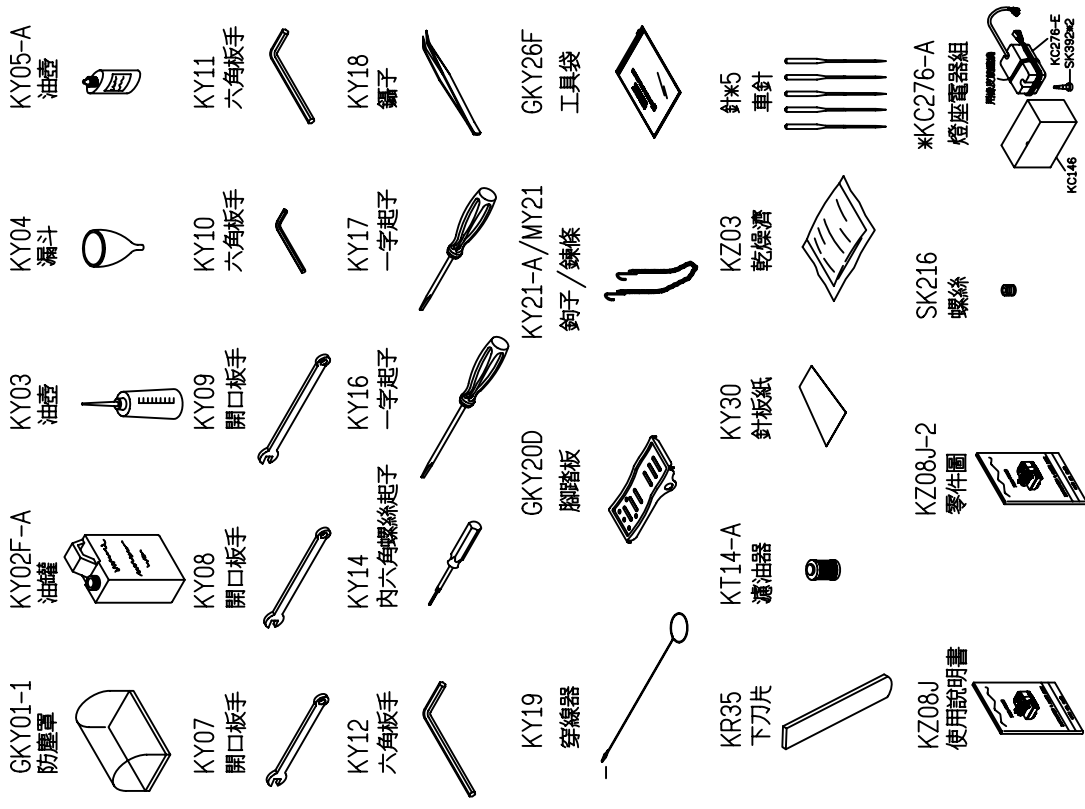

MODEL	700K/KD	988/988D
PARTS NO	KZ53K	KZ53K-1
	*KZ53KD	*KZ53KD-1

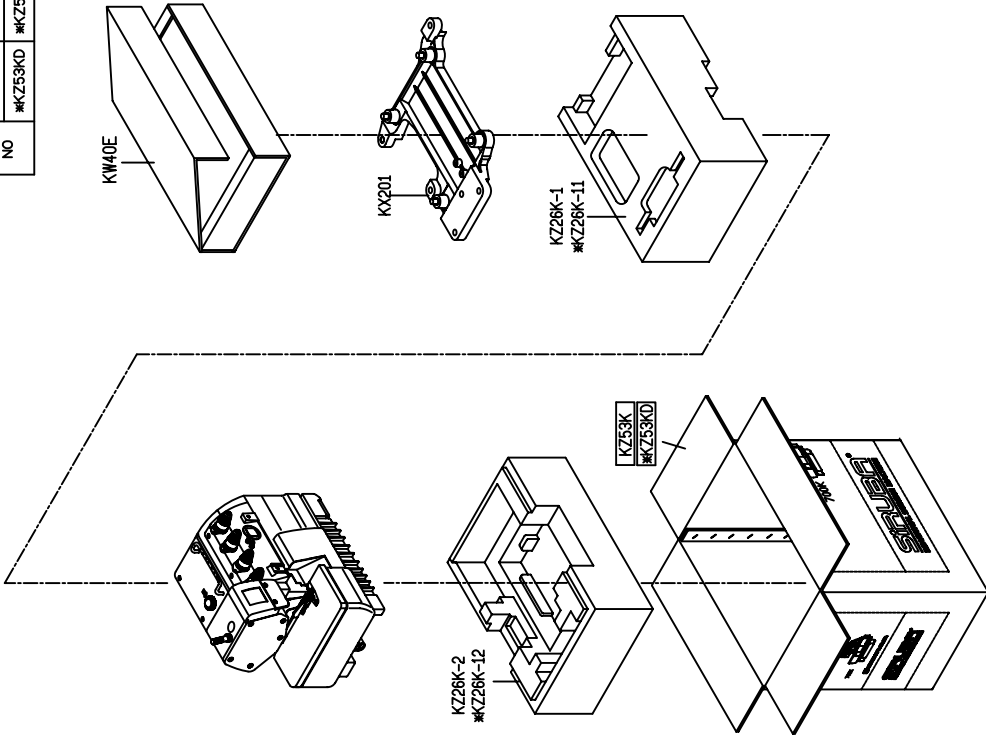



700K

高林股份有限公司 KAULIN MFG. CO., LTD.